

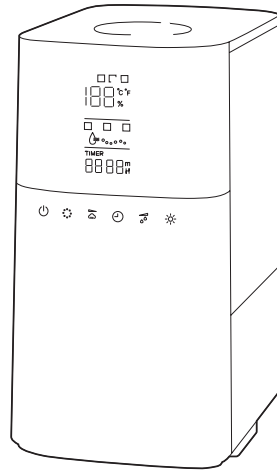

# HUMIDIFIER



Owner's Manual |

Thank you for purchasing your new Ultrasonic Humidifier.

The humidifier helps you to restore an appropriate level of humidity and eliminate the discomfort associated with dry air. We wish you many years of healthy indoor air with this efficient and effective product.

We recommend you spend some time reading this instruction manual in order to fully understand all the operational features it offers.

**\* Read all the safety instructions carefully before use and keep this instruction manual for future reference:**

**Warning:** Please be aware of the following points or you might be in danger of high voltage charges or burn your body.

- 1) Please follow all the safety precautions listed below for safety and to reduce the risk of injury or electrical shock.
- 2) This humidifier can be used by children aged from 8 years and above and persons with reduced physical, sensory or mental capabilities or lack of experience and knowledge if they have been given supervision or instruction concerning use of the humidifier in a safe way and understand the hazards involved. Children shall not play with the humidifier. Cleaning and user maintenance shall not be made by children without supervision.
- 3) Before using this humidifier ensures that the voltage of your electricity supply is the same as that indicated on the rating plate of the humidifier.
- 4) Always place the humidifier on a hard, flat and level surface. Avoid exposure to direct sunlight and always keep it away from walls and heat sources such as stoves, radiators, etc. Warning: The humidifier may not work correctly if it is not placed on a level surface.

- 5) Do not insert or remove the electric plug on the humidifier with wet hands.
- 6) If the mains cable is damaged it must be replaced by the manufacturer, its service agent, or similarly qualified person in order to avoid a hazard.
- 7) To reduce the risk of electric shock, do not remove screws. The humidifier does not contain any user-serviceable parts. Please leave all maintenance work to qualified personnel.
- 8) Fill the tank with fresh, distilled or demineralized water. Do not drop any other liquid into water tank or water basin. Do not run the humidifier when there is no water in the tank or the water basin.
- 9) Do not shake the humidifier as this might cause the water spill over into the base of humidifier.
- 10) Never touch the water or components while the humidifier is in operation.
- 11) If there is an unusual smell when it is being used as described in these manual, switch the humidifier off, unplug it and have it examined by your dealer.
- 12) Do not pour hot water into the tank, i.e. at a temperature in excess of 40°C.
- 13) Unplug the humidifier before cleaning it or removing the tank.
- 14) Do not immerse the humidifier or the mains cable or plug in water or other liquids.
- 15) Never scrape the transducer with a hard tool. The humidifier must be cleaned regularly. To do this, refer to the cleaning instructions in this manual.
- 16) If you spill any liquid into the humidifier, it can cause serious damage. Switch it off at the mains immediately. Withdraw the mains plug and consult your dealer.
- 17) Disconnect the humidifier from the power supply when not in use and before cleaning.
- 18) Ensure that the mains cable does not touch any hot surface and that it does not overhang a table edge.
- 19) Never use this humidifier in a room where aerosol products (sprays) are used or in a room or where oxygen is being administered.
- 20) Do not put items of clothing or towels on top of the humidifier. If the nozzle is obstructed, this may cause the humidifier to malfunction.

- 21) When moving the humidifier, lift it by the base humidifier and not by the water tank.
- 22) Do not use the humidifier if the air in the room is already sufficiently humid.
- 23) The ideal relative humidity level for human comfort is in fact between 45% and 65%. Excess humidity shows up in the form of condensation on cold surfaces or cold walls in the room. To measure the room's humidity correctly, use a hygrometer available in most specialist shops and supermarkets.
- 24) The humidifier is designed for indoor and domestic use only.

**\*Working Principle:** Ultrasonic Humidifier uses the ultrasonic high-frequency oscillator to break up water into tiny water particles with the diameter of about 1-5µm. The ventilation system blows out this water into the dry air where they evaporate to give the required humidity. The clearly visible smooth and even fog can be seen out of the unit.

**\*Features:**

- High efficient in humidification with large output.
- Low energy consumption, save 85-90 percent of electricity than normal stream humidifier.
- Long lifetime
- Automatic control of humidity level, lack-of-water security protection.

- Plasma: Touch the Plasma symbol of Plasma to spread a number of Plasma elements. Press again to stop the Plasma function.
- Base with tray for the felt, to wet it with aromatic oil.

**\*Correct Humidity Level:**

What exactly is relative humidity: Relative humidity is the amount of water vapor in the air, expressed as a percentage of the maximum amount that the air could hold at the given temperature.. We normally mark it with %RH, like 45%RH. Atmospheric air always contains water vapor, the percentage of which depends on the meteorological conditions. The higher the temperature is the more the air keeps water vapor. Therefore, we use the concept of 'relative humidity'. When the cold air is heated up to the comfort temperature in winter, the relative percentage of the water vapor falls which means the relative humidity drops. In order to keep a comfortable and health environment at home, we need some artificial addition of water or water vapor to the room air- that's air humidification.

□ Ideal relative humidity levels under different situations.	
The most comfortable RH for human being	45-65%RH
Ideal RH for prophylactic and curative purpose:	40-55%RH
Computer and telecom apparatuses:	45-60%RH
Furniture and musical instruments:	40-60%RH
Library art gallery and museums:	40-60%RH

## \* FUNCTIONS

### 1: Relative Humidity

1. The percentage of water mist in a given space with a given air temperature is named as relative humidity, usually marked as %RH, i.e. 45%RH. The air contains water mist more or less. The proportion of water mist to the air varies according to different air temperatures. The higher the temperature, the more water mist inhaled in the air.

2. In the winter, the cold air outside enters the room and becomes warmer by the higher temperature in the room. As a result, the relative humidity decreases. If you want to keep the healthy environmental humidity, we need to increase the mist volume in the air. The humidifier can do that for us.

3. Relative humidity in different environments suitable for people:

Bedroom, living room:	45-64%RH
Patient's room:	40-55%RH
Room with computer, experiment equipments:	45-60%RH
Room with piano:	40-60%RH
Museum, exhibition hall, and library:	40-50%RH

### 2: Water filter:

1. Cation exchange resin filter can soften the hard water.
2. Cation exchange resin filter demineralize in the water.

### \*Operation Instruction

First Operation, put unit in the room temperature for half of an hour before running.

It is recommended to use the unit under temperature of 20 degree C, relative humidity less than 80%RH.

Use clear water not over 40 degree C



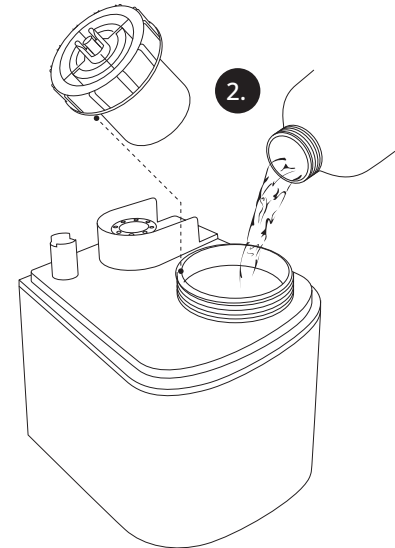

Check the water basin, make sure it is clear.

### INSTRUCTIONS FOR USAGE:



1. Put the machine on a flat surface.
2. Fill the water into the water tank, and then tighten the tank cover.







Temperature of the air, degrees Celsius	Humidity, %
≤19	65
20	60
21	58
22	57
23	55
24	53
25	50
26	48
27	45
28	43
29	40
30	38
31	36
32	35
33	34
34	32
35	31
36	30
37 and higher	25

- Put the water tank on the main base.
- Check if the rated voltage meets the input voltage, and plug into the socket. Then display shows the symbol POWER. 
- Touch the symbol POWER  on the machine; the background LED light will be on. The machine will begin to work in AUTO mode. Display shows AUTO symbol  and shows current humidity and current temperature alternately in 30 seconds. After 15 seconds without any operation, the display will become dim, touch any key except power key to wake up the display. In Auto mode, the device determines the optimal humidity by the formula and starts to achieve it at maximum power. When the current humidity less than the table showed humidity, it is in high speed operation. When the humidity arrived, the machine will be in low speed operation. The device checks the accordance of the temperature level and the humidity level every 1 minute.
- Timer setting: There are 12 timer setting: 1,2,3,4,5,6,7,8,9,10,11,12 hours. Touch the symbol TIMER , the LED display will show the desired setting timer. Touch till "--:--" display on the LED, timer setting is cancelled. The timer shows the rest operation time and decreases by 1 minute, i.e., if the timer is set at 12 hours, LED display shows 11:30 after 30 minutes. To know what



time have been set, just to touch any key except power key to wake up the display and then touch TIMER symbol. Touch again, to set timer again.





There is a shortcut for timer setting. Touching the symbol TIMER  is to increase timer, meanwhile touching symbol MAX / MIN  can reduce timer.

7. Touch the symbol MAX / MIN , AUTO mode is cancelled and the mist output is in the first speed. You may select 3 desired levels of mist volume. The corresponding mist output symbol  shows on the display with different running speed. In mist output level 1, the  is running in low speed, level 2 is running in middle speed, level 3 is running in high speed. Touch the symbol again, to choose AUTO mode.



8. Constant humidity: Before you touch the symbol HUMIDITY , LED display shows the current humidity. You may set the humidity arranged from 30%RH to 90%RH. Touch once, it will increase by 5%RH. When it reaches 90%RH, touch again, it will show "Co" and flash for 3 seconds to exit humidity setting function and back to Auto mode. After you set the expected humidity, the display shows the symbol , the machine will keep the memory and confirm after 5 seconds. 5 seconds later, the symbol %RH will blink and LED display shows the current humidity. Touch again, it shows the expected humidity setting. If the expected humidity is less than the current

humidity, the machine will be in sleeping state. But if the expected humidity is 3% higher than the current humidity, the humidify function will work. Mist output speed cannot be setting during the constant humidity model.

There is a shortcut for humidity setting. Touching the symbol HUMIDITY  is to increase humidity, meanwhile touching symbol MAX / MIN  can reduce humidity.

9. First touch the symbol DEGERMING , the warm mist will come out after 10~15 minutes. On the LED display, it shows the Heating symbol . Second touch, the Plasma generator works as well. On the LED display, it shows both the Plasma symbol  and Heating symbol . Third touch, Heating function will off. Fourth touch to stop both functions.

10. Touch the symbol LIGHT , the brightness of blue decoration light in the bottom and the water tank indication light dimmed. Touch again, become dimmer. Touch 3rd time, will be turned off.

11. Long press the symbol  for 2 seconds, it enters to night mode. Blue decoration light in the bottom and the water tank indication light are off, LED display turns off, leaving the symbol  on the display only. After 5 seconds without any operation, the symbol will become dim, press any key except power key

to wake up the display. Then long press symbol  again to stop the function.

12. Auto Shut-Off: Once the water in the basin is too little to keep the machine working, the machine will automatically stop working. LED shows the shape of lack of water . Refill the water, and the machine will restart. If don't refill water within 15 minutes, the machine will automatically power off.
13. On the remote controller, the related symbol controls the corresponding function.
14. No matter in any working mode, if no any operation in about 15 seconds, the display will turn dim.

#### **Operation steps:**

- Take the water tank out of the unit, open the water tank cover and fill the tank with clear water. Close the cover and put the tank onto the base unit carefully.
- Put the nozzle into the socket on top of the water tank.
- Connect the power supply, switch on the unit (NEVER RUN THE UNIT WHEN THERE IS NO WATER IN WATER BASIN), the main connection lamp will on. The unit will begin working.

#### **\*Trouble Shooting Guide**

If any trouble is found in normal operation, please kindly refer to the following points:



<b>Trouble</b>	<b>Possible reasons</b>	<b>Solution</b>
<b>Power lamp off, does not work</b>	No power supply	Connect power supply, switch on
<b>Power lamp on, no mist outlet with wind</b>	No water in water tank	Fill water into water tank
	Security switch is too loose	Tighten the switch
<b>Abnormal smell mist</b>	New unit	Take out water tank, open cover, let it stay 12 hours in cool position
	Dirty water or water sitting too long	Clean water tank, fill with clear water
<b>Power lamp on, unit doesn't work</b>	Too much water in the water basin	Pull out same water from the water basin, close the cover of water tank tightly
<b>Mist fog is too low</b>	Too much scale in the water basin	Clean transducer
	Water is too dirty or water kept too long in the tank	Clean water tank, change to fresh clear water
<b>Abnormal noise</b>	Resonant in water tank when water is too low	Fill water into water tank
	Unit is on a unstable surface	Move the unit to a stable flat surface
<b>Mist fog coming out from around nozzle</b>	There are apertures between the nozzle and water tank	Dip the nozzle in water for a while and then fix it to the socket on water tank

## TECHNICAL DATA

Model: SPS-921BT

Power supply: 220-240V 50/60Hz

Heating power: 80W

Humidify power: 30W

Total power: 110W

Water tank capacity: 6L

Evaporation Rate:  $\geq 350$ ml/h  $\pm 50$ ml/h

Noise level:  $\leq 35$ dB(A)

### \*Maintenance:

In a case when the water is hard which means water contains too much calcium and magnesium, it can cause a “white powder” problem and leave heavy scales on the surface of water basin, transducer and inner surface of the water tank. Scales on the surface of transducer will let the unit work improperly.

### We recommend:

- 1) Use cold boiled water or distilled water.
- 2) Clean the transducer, water tank and basin unit every week.
- 3) Change the water in water tank more often to keep it fresh.
- 4) Make sure to pull out the water from the water tank and dry the water basin before you store the unit unused for a long period of time.
- 5) Clean the whole unit and make sure that all parts of the unit are dried completely before unused for longer period of time.

### How to clean the transducer:

- 1) Put 5-10 drops of cleaning abluent on the surface of the transducer, wait for 2-5 minutes.
- 2) Brush off the scale from the surface.
- 3) Rinse the transducer with clean water.

### How to clean the basin unit:

- 1) Clean the water basin with soft cloth and the cleaning abluent if there is scale in it.
- 2) If the scale is covered on the security switch, drop the cleaning abluent on the scale and clean it out with the brush.
- 3) Rinse the water basin with clean water.

**DISPOSAL:** Do not dispose this product as unsorted municipal waste, collection of such waste separately for special treatment is necessary.



DE

Allclean Reinigungs- und  
Umwelt-Technik GmbH  
Steinbergstraße 3  
04288 Leipzig  
+49 (0) 34297 609 610  
E-mail: INFO@ALLCLEAN.DE  
www.luxinternational.com/de

AT

Lux Österreich GmbH  
Concorde Business Park 1/B3/Top 31  
2320 Schwechat  
Österreich  
Tel: +43 1 706 42 52  
E-Mail: oesterreich@luxaustria.at  
www.luxaustria.at

CH

Lux Schweiz AG  
Neue Winterthurerstrasse 30  
CH-8304 Wallisellen/Zürich  
Tel: +41 62 749 37 70  
Switzerland  
E-Mail: luxschweiz@luxinternational.com  
www.luxinternational.com/ch

CZ

Lux Czech s.r.o.  
Nepilova 903/3  
190 00 Praha 9  
Tel: 220 000 871  
www.luxczech.cz  
info@luxczech.cz

Lux

Lux International AG  
Neue Winterthurerstrasse 30  
CH-8304 Wallisellen/Zürich  
Switzerland  
Email: info@luxinternational.com  
www.luxinternational.com

DK

N2C ApS - Lux Denmark  
Lerbaekvej 8  
DK - 2680 Solroed Strand  
www.nordic2care.com

EE

Lux Eesti OÜ  
Vabaduse pst 13  
EE-11214 Tallinn  
Tel: + 372 67 44 700  
www.luxeesti.ee

ES

Lux Welity Spain  
Pez Volador 32 Bajo C  
ES - 28007 Madrid  
Tel: 91 557 1128  
www.lux.es

FI

Oy Hedengren Direct AB  
Lauttasaarentie 50  
FI-00200 Helsinki  
Tel: +358 207 638 000  
www.hedengrendirect.fi

HU

Lux Hungária Kereskedelmi Kft.  
Jávor utca 5/a.  
1145 Budapest  
Magyarország  
Tel: +36 1 422 4444  
E-Mail: info@luxhungaria.hu  
www.luxhungaria.hu

IT

D.E.S. S.r.l.  
Via Perugino 10  
24068 Seriate (BG)  
Italia  
Tel: +39 035 4236010  
E-Mail: info@des-lux.it  
www.viveresano.eu

LT

UAB "Lux LT"  
Smelio g. 10  
LT - 10324 Vilnius  
Tel: +370 650 288 03  
E-Mail: luxlt@luxeesti.ee  
www.luxlietuva.eu

LV

Lux Latvia SIE  
Maskavas 240 - 508  
LV-1063 Riga  
Tel: +371 277 18 555  
E-Mail: luxriga@gmail.com  
www.luxlatvija.lv

NO

Lux Norge AS  
Postboks 9505 Åskollen  
3066 Drammen  
Tel: 22 74 99 90  
www.lux.no

SE

Lux Svenska AB  
Industrivägen 1  
SE-171 48 Solna  
Tel: +46 8 622 27 40  
www.lux.se

PL

Lux Welity Polska Sp. z o.o.  
ul.Międzyborska 27a  
60-162 Poznań  
Tel.: +48 61 22 177 99  
biuro@luxpolska.pl  
www.luxwelity.pl

SK

Lux (SK), s.r.o.  
Hany Melickovej 1/F  
SK - 841 05 Bratislava  
Tel: + 421 232 77 97 15  
www.lux-com.sk



